

up to 4000 kg per mount

Economical Wedgmount® for precise leveling, ideal stability and non-skid properties

Cost effective, high quality and easy machine installations are demanded by equipment manufacturers. AirLoc has responded to these challenges and developed a new type of Wedgmount® called EcoFixx.

EcoFixx has been specifically designed for machines requiring high precision, fast, safe and most importantly, economic installation.

EcoFixx reflects 60 years of experience in research, development and production of precision machinery mounts and delivers speed, safety and (last but not least) high profitability.

Developed with the latest 3D CAD modeling tools, tested with precision measuring equipment in our test lab and produced in-house with state-of-the-art machines, combined to provide a high quality, economical solution.

- ▶ Easy, safe and economical machine installation
- ▶ Contamination protected leveling system for long lasting, consistent performance
- ▶ Freestanding, bolt-on or socket mounted designs for machine requirements
- ▶ Built-in mis-alignment compensation up to 2° with height adjustment rings optional for uneven floors
- ▶ Compact and rugged design with maximum flexibility to fit and last under all types of machines

The economical EcoFixx Wedgmount® Precision Levelers are characterized by the following features and benefits:

- Maximum design freedom - Compact size to fit in limited space
- Freestanding, Bolt-on and socket mounted versions
- Protected against contamination of moving parts
- Fast precise leveling for easy installation
- Low leveling torque for easy adjustment
- Rugged spherical seat for bolt-on version on uneven floors
- Provides excellent vibration isolation utilizing proven AirLoc pads

Ask for the AirLoc catalogue free of charge!

Color
Jet Black RAL 9005

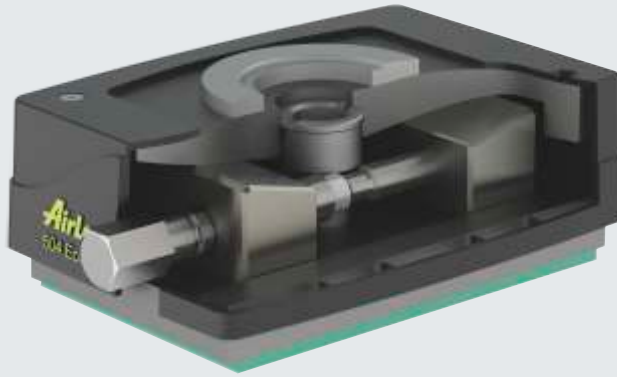

EcoFixx offers a compact, contamination protected adjustment system, which enables fast and precise machine leveling.

Technical Data



Freestanding

	Article-No.	Load daN	H mm	L mm	B mm	d ₁ mm	Leveling mm	Torque Nm
504-VRC/NG	1.30504.62	1750	63					5
504-VRC/NE	1.30504.60	4000	51	136	97		+/- 3.5	15
504-VRC/NK	1.30504.65	4000	63					15

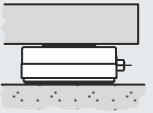

Bolt-on

504.1-VRKC/716	1.36504.56	1750	64			M12		5
504.1-VRKC/902	1.36504.59	4000	51	136	97	+	+/- 3.5	15
504.1-VRKC/915	1.36504.65	4000	64			M16		15

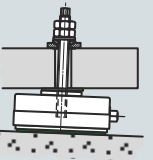

Socket

504.6-VRKCS/715	1.53504-6.57	1750	67			M12		5
504.6-VRKCS/902	1.53504-6.59	4000	54	136	97	+	+/- 3.5	15
504.6-VRKCS/915	1.53504-6.65	4000	67			M16		15

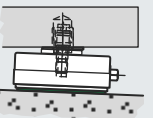

Freestanding

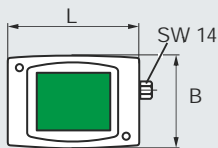

Bolt-on, Socket mounted

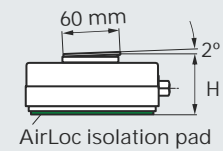
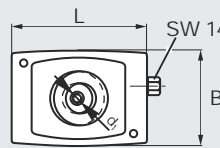

AirLoc Schrepfer LTD
Industriestrasse 2, CH-8618 Oetwil am See
Telephone +41 44 929 77 00, Fax +41 44 929 77 10
www.airloc-schrepfer.com, info@airloc-schrepfer.com

Worldwide Distributors
Please visit us in the Internet at www.airloc-schrepfer.com
for details about our worldwide distributors.

All information and specifications are true and correct to the best of our knowledge; they do not represent an assurance of properties and do not release users from examination on their own, also with reference to the trademark rights of third parties. Technical revisions are subject to change without prior notice.