



Crossed Roller Bearings

Technical Information



Multi Axis Robot

- Pick-and-place / Assembly / Array and packaging / Semiconductor / Electro-Optical industry / Automotive industry / Food industry
- Articulated Robot
 - Delta Robot
 - SCARA Robot
 - Wafer Robot
 - Electric Gripper
 - Integrated Electric Gripper
 - Rotary Joint



Single Axis Robot

- Precision / Semiconductor / Medical / FPD
- KK, SK
 - KS, KA
 - KU, KE, KC



Direct Drive Rotary Table

- Aerospace / Medical / Automotive industry / Machine tools / Machinery industry
- RAB Series
 - RAS Series
 - RCV Series
 - RCH Series



Ballscrew

- Precision Ground / Rolled
- Super S series
 - Super T series
 - Mini Roller
 - Ecological & Economical lubrication Module E2
 - Rotating Nut (R1)
 - Energy-Saving & Thermal-Controlling (C1)
 - Heavy Load Series (RD)
 - Ball Spline



Linear Guideway

- Automation / Semiconductor / Medical
- Ball Type--HG, EG, WE, MG, CG
 - Quiet Type--QH, QE, QW, QR
 - Other--RG, E2, PG, SE, RC



Medical Equipment

- Hospital / Rehabilitation centers / Nursing homes
- Robotic Gait Training System
 - Hygiene System
 - Robotic Endoscope Holder



Bearing

- Machine tools / Robot
- Crossed Roller Bearings
 - Ball Screw Bearings
 - Linear Bearing
 - Support Unit



AC Servo Motor & Drive

- Semiconductor / Packaging machine / SMT / Food industry / LCD
- Drives-D1, D1-N, D2
 - Motors-50W-2000W



Driven Tool Holders

- All kinds of turret
- VDI Systems
 - Radial Series, Axial Series, MT
 - BMT Systems
 - DS, NM, GW, FO, MT, OM, MS



Linear Motor

- Automated transport / AOI application / Precision / Semiconductor
- Iron-core Linear Motor
 - Coreless Linear Motor
 - Linear Turbo Motor LMT
 - Planar Servo Motor
 - Air Bearing Platform
 - X-Y Stage
 - Gantry Systems



Torque Motor (Direct Drive Motor)

- Inspection / Testing equipment / Machine tools / Robot
- Rotary Tables-TMS,TMY,TMN
 - TMRW Series
 - TMRI Series

INDEX

HIWIN Crossed Roller Bearings (CRB Series)	1
Introduction	1
Product Features	1
Specification	1
Types of Crossed Roller Bearings.....	2
Structure of sealed type and open type	4
Accuracy	4
Selecting a Crossed Roller Bearing	7
Dynamic Equivalent Load, P.....	7
Basic Life Rating, L	7
Static Equivalent Load, P ₀	7
Safety Factor, f _s	8
Example calculation of the basic life rating and the safety factor	8
Recommended fit	9
How to fix the bearing and the design of the bracket and mounting disc	9
Installation steps	10
Other Information	11
Lubrication	11
Allowable RPM	11
Cautions	11
CRBA Product Specification	12
CRBB Product Specification	13
CRBC Product Specification	14
CRBD Product Specification	15
CRBE Product Specification	16

HIWIN Crossed Roller Bearings (CRB Series)

Introduction

HIWIN Crossed Roller Bearings consist mainly of an outer ring, an inner ring and a plurality of rollers and spacers. The rollers lie between the inner ring and the outer ring. The spacer is placed between rollers to prevent the mutual friction so as to decrease the torque resistance for rotation. In addition, the surface of the roller and the rolling track is linear contact. So, when the bearing is loaded, the loading area will be very large. Thus, the elastic deformation will be less, and the bearing will achieve longer service life. Each roller in a Crossed Roller Bearing is crossed at a 90° angle, which is able to handle the loading force from multiple directions at the same time.

HIWIN offers the following six types of Crossed Roller Bearings defined by the following as the split outer ring type (CRBA), the split inner ring type (CRBB), the high rigidity type (CRBC), the split outer ring with mounting holes (CRBD), the high rigidity with mounting holes (CRBE) and the customized type (CRBX). The split outer ring type is suitable for rotating the inner ring. The split inner ring type is suitable for rotating the outer ring. The high rigidity type is suitable for rotating both the inner ring and outer ring. The mounting holes could be used to aid in the assembly. The customized type could be modified to meet the customer requirements. Crossed Roller Bearings possess high rigidity and high rotational accuracy, which could be widely used in industrial automation control, robotics, machine tools, inspection and medical devices.

Product Features

1. Patented design features high loading capacity
2. High rigidity
3. Dimensional and rotational accuracy tolerance range is tighter than international standards
4. Accepts loads from all directions at the same time
5. Smooth rotation
6. Compact, space saving
7. Easy installation and adjustment
8. Various bearing types and sizes to accommodate your requirements
9. Customized designs available



Specification

1. Model Code: of bearings. CRB stands for Crossed Roller Bearing. Six types of CRB, which are defined by the following:
 A: split outer ring.
 B: split inner ring.
 C: high rigidity.
 D: split outer ring with mounting holes.
 E: high rigidity with mounting holes.
 X: customized.
2. Bore Diameter: (unit: mm). For example, 080 represents the bore diameter of 80 mm, and 100 represents the bore diameter 100 mm.
3. Width: (unit: mm).
4. Mounting Holes: If left blank, it represents a bearing without mounting holes.
 A represents the bearing with mounting screw holes,
 B represents the bearing with same direction counter-bored holes, and
 C represents the bearing with opposite direction counter-bored holes.
5. Seal Symbol: WW signifies seals on both sides. NN signifies the open type without seals. Both types have oil holes for lubrication.
6. Axial internal clearance: C1 signifies positive clearance with less friction force, while C8 signifies negative clearance without backlash, which will result in an increase of friction force during unloading conditions.
7. Accuracy class: General Class 5 (P5), Class 4 (P4), Class 2 (P2), Class D5 (PD5), Class D4 (PD4) and Class D2 (PD2). Please see Tables 1~7 for standard accuracy grades.

CRBD 080 22 A WW C8 P5

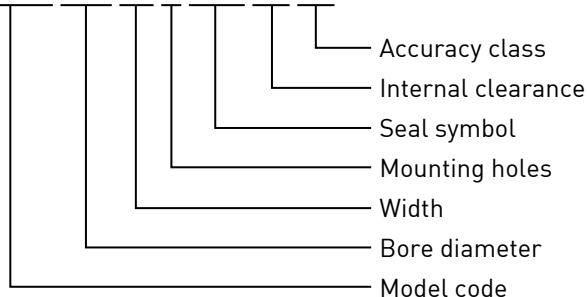

Types of Crossed Roller Bearings

1. Split outer ring type (CRBA)

Consists of an inner ring and two outer semi-rings, which is suitable for inner ring rotation.



2. Split inner ring type (CRBB)

Consists of two inner semi-rings and an outer ring, which is suitable for outer ring rotation.

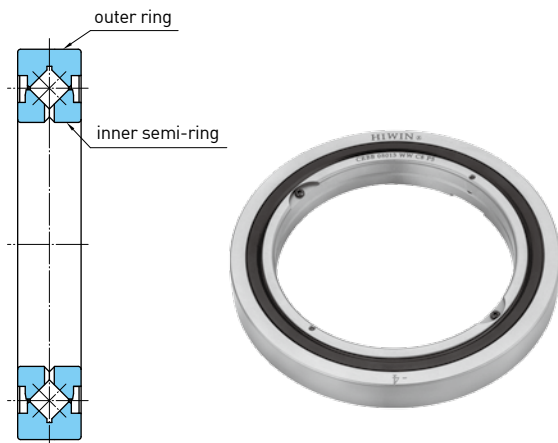

3. High rigidity type (CRBC)

Consists of an inner ring and an outer ring, which is suitable for both inner and outer ring rotation.

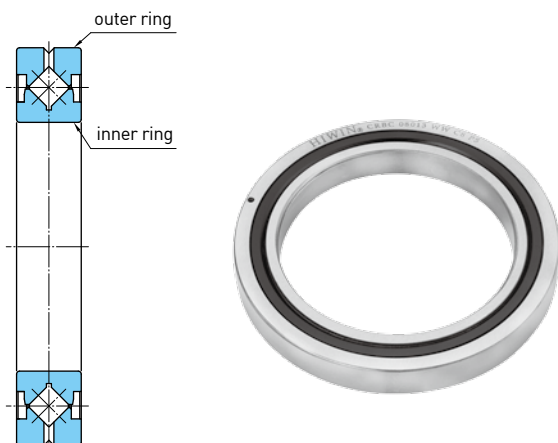

4. Split outer ring with mounting holes (CRBD)

Consists of an inner ring and two outer semi-rings with mounting holes. The mounting holes, enable the bearing to be fixed and it is suitable for inner ring rotation .



5. High rigidity with mounting holes (CRBE)

Consists of an inner ring and an outer ring with mounting holes. The mounting holes, enable the bearing to be fixed and it is suitable for both inner and outer ring rotation .

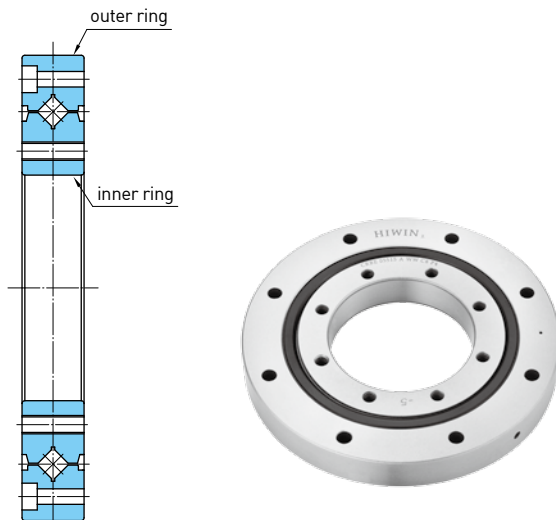

6. Customized type (CRBX)

The bearing could be designed and modified in accordance with the customers requirements to achieve a more innovative structure. The surface treatment could also be customized to meet the customers' environmental requirements.



Structure of sealed type and open type

- 1. Sealed type:** The seal will prevent any foreign substance from entering the track as well as preventing lubrication leakage. The sealed type has oil holes for lubrication.
- 2. Open type:** Non-seal structure makes the friction smaller, and it is suitable for low torque application. The open type also equips with oil holes for lubrication.

Accuracy

Table 1 Bore diameter accuracy

Unit : μm

Nominal bore diameters, d (mm)		Bore diameter deviations, Δd_{mp}					
		P5, P4, P2		PD5		PD4, PD2	
over	include	high	low	high	low	high	low
18	30	-1	-9	-1	-6	-1	-5
30	50	-2	-11	-1	-7	-1	-6
50	80	-3	-13	-1	-9	-1	-7
80	120	-3	-15	-1	-10	-1	-8
120	150	-4	-18	-2	-11	-1	-9
150	180	-4	-25	-2	-13	-1	-10
180	250	-4	-30	-2	-15	-1	-11
250	315	-5	-35	-3	-18	-	-
315	400	-6	-40	-3	-20	-	-

Notes:1. " d_{mp} " means the average of maximum and minimum value of inner diameter.

2. HIWIN bore diameter tolerance range is tighter than international standards ISO 199, 492, 582. If you need higher accuracy, please contact HIWIN.
3. HIWIN CRBA, CRBB have accuracy grades of P5, P4, P2, PD5. If you need higher accuracy, please contact HIWIN.
4. HIWIN CRBC has accuracy grades of P4, P2, PD4, PD2.
5. HIWIN CRBD has accuracy grades of P5, P4. If you need higher accuracy, please contact HIWIN.
6. HIWIN CRBE has accuracy grades of P4, P2. If you need higher accuracy, please contact HIWIN.

Table 2 Outside diameter accuracy

Unit : μm

Nominal outside diameters, D (mm)		Outside diameter deviations, ΔD_{mp}					
		P5, P4, P2		PD5		PD4, PD2	
over	include	high	low	high	low	high	low
18	30	-1	-9	-1	-6	-1	-5
30	50	-2	-11	-1	-7	-1	-6
50	80	-3	-13	-1	-9	-1	-7
80	120	-3	-15	-1	-10	-1	-8
120	150	-4	-18	-2	-11	-1	-9
150	180	-4	-25	-2	-13	-1	-10
180	250	-4	-30	-2	-15	-1	-11
250	315	-5	-35	-3	-18	-1	-13
315	400	-6	-40	-3	-20	-1	-15
400	500	-7	-45	-3	-23	-	-

Notes:1. " D_{mp} " means the average of maximum and minimum value of outside diameter.

2. HIWIN outside diameter tolerance range is tighter than international standards ISO 199, 492, 582. If you need higher accuracy, please contact HIWIN.
3. HIWIN CRBA \ CRBB have accuracy grades of P5, P4, P2, PD5. If you need higher accuracy, please contact HIWIN.
4. HIWIN CRBC has accuracy grades of P4, P2, PD4, PD2.
5. HIWIN CRBD has accuracy grades of P5, P4. If you need higher accuracy, please contact HIWIN.
6. HIWIN CRBE has accuracy grades of P4, P2. If you need higher accuracy, please contact HIWIN.

Table 3 Width accuracy

Unit : μm

Nominal bore diameters, d (mm)		Width deviations of inner (or outer) ring, $\Delta B_s, \Delta T_s$			
		CRBA inner ring, CRBD inner ring		CRBA outer ring, CRBD outer ring	
		CRBB outer ring			
		CRBC inner ring, CRBC outer ring		CRBB inner ring	
		CRBE inner ring, CRBE outer ring			
over	include	high	low	high	low
18	30	0	-75	0	-100
30	50	0	-75	0	-100
50	80	0	-75	0	-100
80	120	0	-75	0	-100
120	150	0	-100	0	-120
150	180	0	-100	0	-120
180	250	0	-100	0	-120
250	315	0	-120	0	-150
315	400	0	-150	0	-200

Table 4 Rotational accuracy for the inner ring of CRBA and CRBC

Unit : μm

Nominal bore diameters, d (mm)		Radial runout of inner ring, K_{ia}			Inner ring face runout with raceway, S_{ia}		
		PD5	PD4	PD2	PD5	PD4	PD2
		P5	P4	P2	P5	P4	P2
over	include	max	max	max	max	max	max
18	30	3	3	2	4	3	2
30	50	4	3	2	5	3	2
50	80	4	3	2	5	4	2
80	120	5	4	2	6	4	2
120	150	6	5	2	8	6	2
150	180	6	5	4	8	6	4
180	250	8	6	4	10	6	4
250	315	10	8	-	13	8	-
315	400	12	9	-	15	9	-

- Notes: 1. Radial runout of inner ring (K_{ia}) and inner ring face runout with raceway (S_{ia}) are not used on the CRBB type.
 2. HIWIN runout tolerance limit is 75% of the amount listed in ISO standards 199, 492, 582.
 3. HIWIN CRBA has accuracy grades of P5, P4, P2, PD5. If you need higher accuracy, please contact HIWIN.
 4. HIWIN CRBC has accuracy grades of P4, P2, PD4, PD2.

Table 5 Rotational accuracy for the outer ring of CRBB and CRBC

Unit : μm

Nominal outside diameters, D (mm)		Radial runout of outer ring, K_{ea}			Outer ring face runout with raceway, S_{ea}		
		PD5	PD4	PD2	PD5	PD4	PD2
		P5	P4	P2	P5	P4	P2
over	include	max	max	max	max	max	max
18	30	5	3	2	6	4	2
30	50	6	4	2	6	4	2
50	80	6	4	3	8	4	3
80	120	8	5	4	9	5	4
120	150	9	6	4	10	6	4
150	180	10	6	4	11	6	4
180	250	12	8	6	12	8	6
250	315	14	9	6	14	8	6
315	400	15	10	6	15	10	6
400	500	18	12	-	18	12	-

- Note: 1. Radial runout of outer ring (K_{ea}) and outer ring face runout with raceway (S_{ea}) are not applicable on the CRBA type.
 2. HIWIN runout tolerance limit is 75% of the amount listed in ISO standards 199, 492, 582.
 3. HIWIN CRBB has accuracy grades of P5, P4, P2, PD5. If you need higher accuracy, please contact HIWIN.
 4. HIWIN CRBC has accuracy grades of P4, P2, PD4, PD2.

Table 6 Rotational accuracy for the inner ring and outer ring of CRBD

Unit : μm

Bearing No.	Radial runout of inner ring, K_{ia}		Inner ring face runout with raceway, S_{ia}		Radial runout of outer ring, K_{ea}		Outer ring face runout with raceway, S_{ea}	
	P5	P4	P5	P4	P5	P4	P5	P4
	max	max	max	max	max	max	max	max
CRBD 02012	3	3	4	3	6	4	8	4
CRBD 03515	4	3	5	3	8	5	9	5
CRBD 05515	4	3	5	4	8	5	9	5
CRBD 08022	4	3	5	4	10	6	11	6
CRBD 09025	5	4	6	4	12	8	12	8
CRBD 11528	5	4	6	4	12	8	12	8
CRBD 16035	6	5	8	6	14	9	14	8

Note: HIWIN runout tolerance limit is 75% of the amount listed in ISO standards 199,492,582.

Table 7 Rotational accuracy for inner ring and outer ring of CRBE

Unit : μm

Bearing No.	Radial runout of inner ring, K_{ia}		Inner ring face runout with raceway, S_{ia}		Radial runout of outer ring, K_{ea}		Outer ring face runout with raceway, S_{ea}	
	P2	P4	P2	P4	P2	P4	P2	P4
	max	max	max	max	max	max	max	max
CRBE 02012	2	3	2	3	3	4	3	4
CRBE 03515	2	3	2	3	4	5	4	5
CRBE 05515	2	3	2	4	4	5	4	5
CRBE 08022	2	3	2	4	4	6	4	6
CRBE 09025	2	4	2	4	6	8	6	8
CRBE 11528	2	4	2	4	6	8	6	8
CRBE 16035	4	5	4	6	6	9	6	8
CRBE 21040	4	6	4	6	6	10	6	10

Note: Hiwin runout tolerance limit is 75% of the amount listed in ISO standards 199,492,582.

Table 8 Internal clearance

Unit : μm

Nominal bearing bore diameters, D_{pw} (mm)		Clearances			
		C8		C1	
over	include	min	max	min	max
30	50	-8	0	2	15
50	80	-10	0	2	20
80	120	-10	0	2	20
120	140	-10	0	2	20
140	160	-10	0	2	20
160	180	-10	0	2	20
180	200	-10	0	2	20
200	225	-10	0	2	20
225	250	-10	0	2	20
250	280	-15	0	2	25
280	315	-15	0	2	25
315	355	-15	0	2	25
355	400	-15	0	2	25
400	450	-20	0	2	25

Selecting a Crossed Roller Bearing

The general selection for a Crossed Roller Bearing is shown below:

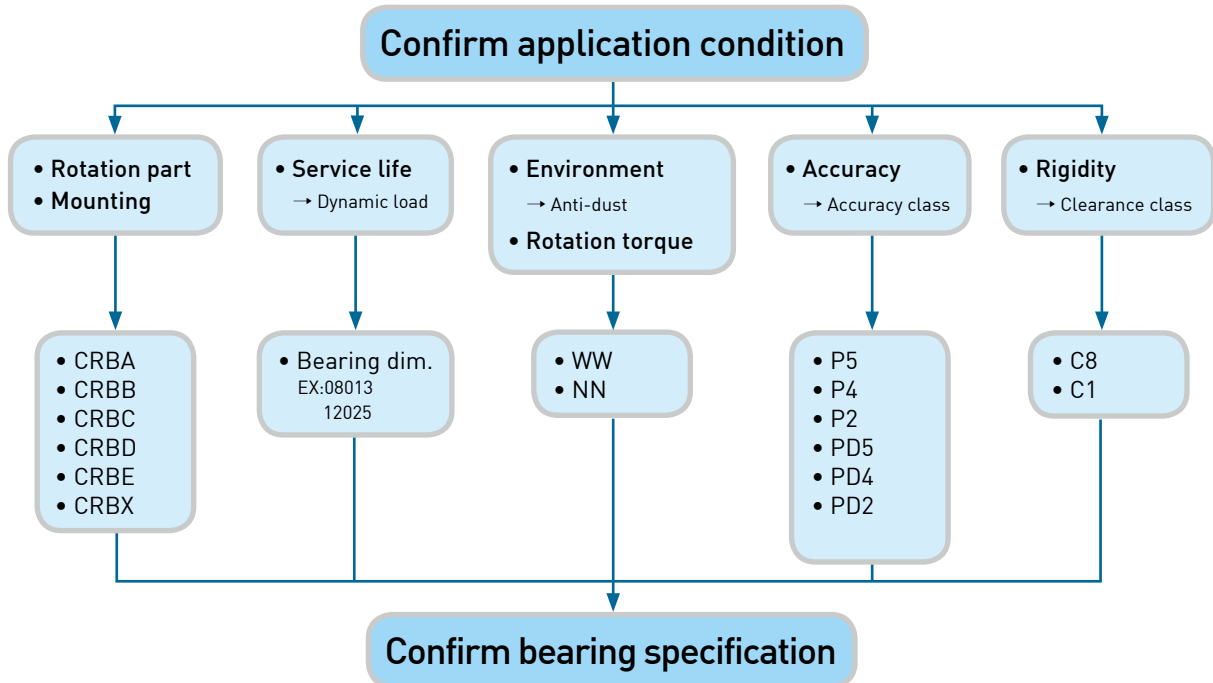

Dynamic Equivalent Load, P

When the acting load is radial load, axial load and torque, all loads can be combined to a single load acting on the center of bearing. It is called the dynamic equivalent load, and is represented by equation (1):

$$P = X \left(F_r + \frac{2M}{D_{pw}} \right) + Y F_a \dots\dots\dots (1)$$

where, $X = 1, Y = 0.45$ for $\frac{F_a}{F_r + 2M/D_{pw}} \leq 1.5$

$X = 0.67, Y = 0.67$ for $\frac{F_a}{F_r + 2M/D_{pw}} > 1.5$

In equation (1), P is the dynamic equivalent load; F_r is the radial load; F_a is the axial load; the unit of P, F_r and F_a is Newton (N) or kilogram force (kgf); M is the torque in N · mm or kgf · mm; X and Y are the radial and axial load coefficients; the pitch circle diameter, $D_{pw} = (\text{inside diameter of bearing, } d + \text{outside diameter of bearing, } D)/2$, and the unit is mm.

Basic Life Rating, L

The basic life rating means 90% of bearings will not fail after operating for a certain revolution under the same operating condition. Equation (2) can be used to calculate the basic life rating under a constant load and a constant revolution:

$$L = \left(\frac{C}{P} \right)^{\frac{10}{3}} \dots\dots\dots (2)$$

In equation (2), L is the basic life rating of the bearing in 10^6 revolutions; P is the dynamic equivalent load; C is the basic dynamic load rating; and the unit of P and C should be the same in either Newton (N) or kilogram force (kgf).

Static Equivalent Load, P_0

When the bearing experiences a radial load, axial load and torque, the permanent deformation will take place at the contact location of the roller and the track. This load is referred to as the static equivalent load, which can be calculated using equation (3):

$$P_0 = F_r + \frac{2M}{D_{pw}} + 0.44 F_a \quad \dots\dots\dots (3)$$

In equation (3), P_0 is the static equivalent load; F_r is the radial load; F_a is the axial load; the unit of P_0 , F_r and F_a should be the same in either N or kgf; M is the torque in N · mm or kgf · mm, the force unit should be the same as P_0 , F_r and F_a ; the pitch circle diameter, $D_{pw} = (\text{inside diameter of bearing, } d + \text{outside diameter of bearing, } D)/2$, and the unit is mm.

Safety Factor, f_s

The safety factor (f_s) is determined by the basic static load rating (C_0) and the static equivalent load (P_0), as shown in equation (4). The suggested safety factor based on the bearings operation condition is shown in Table 9:

$$f_s = \left(\frac{C_0}{P_0} \right) \quad \dots\dots\dots (4)$$

Where C_0 and P_0 are the basic static load rating and the static equivalent load, and the unit should be the same in either N or kgf.

Table 9 Operation condition and the suggested safety factor

Operation condition	Safety factor (f_s)
Standard operation	≥ 1.5
Bearing with vibrating load	≥ 2
High rotation and high accuracy	≥ 3

Example calculation of the basic life rating and the safety factor

Bearing: CRBA 15025 WW

Inside diameter $d = 150$ mm	$W_1 = 800$ N
Outside diameter $D = 210$ mm	$W_2 = 2200$ N
Pitch circle diameter, $D_{pw} = 180$ mm	
Basic dynamic load rating $C = 73100$ N	$F_r = 3000$ N
Basic static load rating $C_0 = 131900$ N	$L = 800$ mm

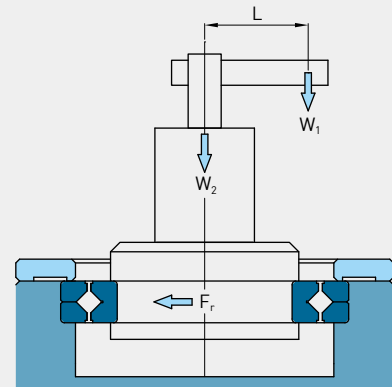

Calculation:

Radial load: $F_r = 3000$ N

Axial load: $F_a = W_1 + W_2 = 800 + 2200 = 3000$ N

Torque: $M = W_1 \times L = 800 \times 800 = 640000$ N · mm

Pitch circle diameter: $D_{pw} = (d + D)/2 = (150 + 210)/2 = 180$ mm

$$\frac{F_a}{F_r + 2M/D_{pw}} = \frac{3000}{3000 + 2 \times 640000 / 180} \cong 0.297 < 1.5$$

Radial load coefficient, $X = 1$, axial load coefficient, $Y = 0.45$

Dynamic equivalent load:

$$P = X \left(F_r + \frac{2M}{D_{pw}} \right) + Y F_a = 1 \times \left(3000 + \frac{2 \times 640000}{180} \right) + 0.45 \times 3000 \cong 11461$$
 N

Static equivalent load:

$$P_0 = F_r + \frac{2M}{D_{pw}} + 0.44 F_a = 3000 + \frac{2 \times 640000}{180} + 0.44 \times 3000 \cong 11431$$
 N

Basic life rating: $L = \left(\frac{C}{P} \right)^{\frac{10}{3}} = \left(\frac{73100}{11461} \right)^{\frac{10}{3}} \cong 481(x10^6 \text{ rev.})$

Safety factor: $f_s = \left(\frac{C_0}{P_0} \right) = \frac{131900}{11431} \cong 11.5$

Notes: 1. If the axial load (F_a), the radial load (F_r) and the torque (M) are applied on the bearing, no direction should be considered for these three loads because they are all positive values.

2. 1 N = 0.102 kgf = 0.2248 lbs; 1 mm = 0.03937 inch.

Recommended fit

Table 10 Suggested tolerance of shaft and bearing housing

Clearance type	Load condition		Suggested fit	
			Shaft	Bearing housing
C8	Rotation load of inner ring	Common load	h5 (0~5 μm of interference fit)	H6 (0~10 μm of interference fit)
		High vibrating load		
	Rotation load of outer ring	Common load	g5 (0~10 μm of interference fit)	JS6 or J6 (0~5 μm of interference fit)
		High vibrating load		
C1	Rotation load of inner ring	Common load	js5 or j5	H6
		High vibrating load	k5	JS6 or J6
	Rotation load of outer ring	Common load	g5	JS6 or J6
		High vibrating load	h5	K6

Note: 1. When the bearing has a higher preload, the fitting way in parentheses should be used.

Example 1:

The axial clearance class is C8, the inner ring is rotated (outer ring is not rotated), the split outer ring type (CRBA) is suggested.

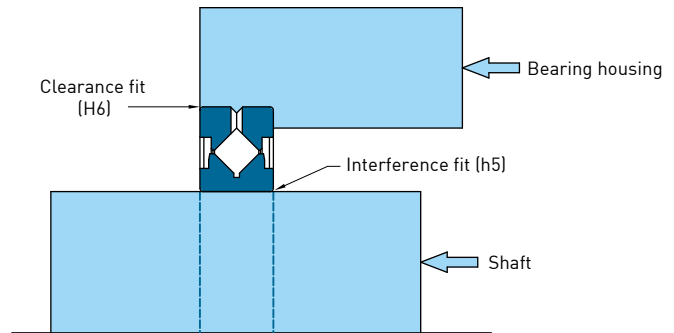

Example 2:

The axial clearance class is C8, the outer ring is rotated (inner ring is not rotated), the split outer ring type (CRBB) is suggested.

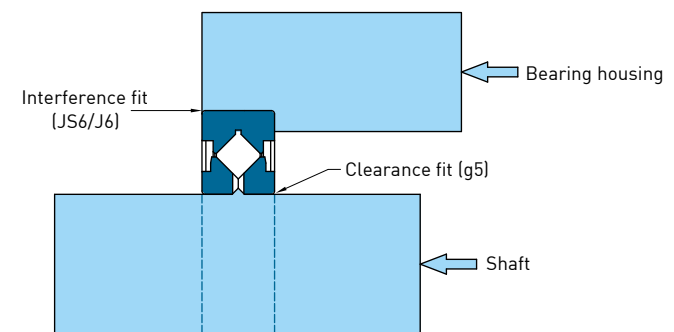

How to fix the bearing and the design of the bracket and mounting disc

The bracket and the mounting disc are parts for supporting and clamping the bearing. The Crossed Roller Bearing has a thin wall, so it is necessary to consider the rigidity of both the bracket and the mounting disc. When the split type of bearing is used, and the rigidity of both the bracket and the mounting disc is insufficient, the bearing will be deformed due to uneven pressure of the inner ring and outer ring, resulting in reduced performance and stability. In order to prevent this occurrence, the bracket and mounting disc should be designed as follows:

Housing: The wall thickness of the bracket, T , can be calculated by equation (5):

$$T > \frac{D-d}{2} \times 0.6 \dots\dots\dots (5)$$

In equation (5), D is the outside diameter of the outer ring; d is the inside diameter of the inner ring. Steel is the material used for the bracket in this equation. If aluminum or aluminum alloy is used, it should be adjusted in accordance with the property of that material.

In addition, screw holes can be added into the bracket. So, when the bearing needs to be removed, the bolts can be used to eject the bearing from the bracket without damaging the bearing. As for the dimension of the Mounting disc(Da, da), please refer to the relevant dimension shown in the bearing specification.

Mounting disc: The wall thickness (E) and the clearance (S) of the mounting disc can be calculated by equation (6).

$$E = B \times 0.5 \sim B \times 1.2$$

$$H = B \begin{matrix} +0 \\ -0.1 \end{matrix} \dots\dots\dots (6)$$

$$S = 0.5\text{mm}$$

Refer to Table 11 for the number of bolts used for the outer ring mounting disc. If the inner ring mounting disc is used, the inside diameter of the bearings inner ring can be substituted into Table 11 for calculating the number of bolts. If medium hard steel is used for the bracket or the mounting disc, the torque value shown in Table 12 can be used for tightening the bolts. Additionally, the dimensional tolerance of the parts should be considered while installing the mounting disc in order to make the mounting disc and the inner and outer ring combined closely.

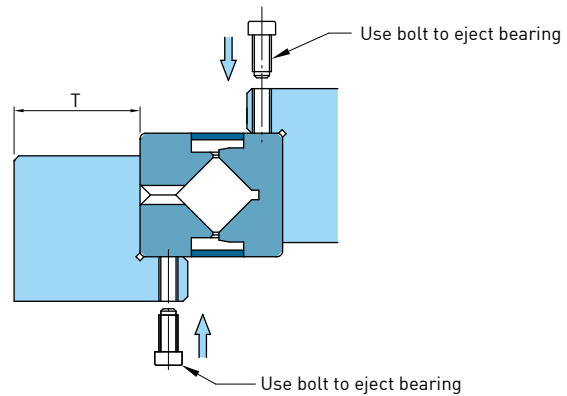

For high accuracy demand, mounting disc are designed with a section difference which can be used to adjust the tightening force by grinding the section surface.

Mounting disc made of steel are suggested to design with a 0.02~0.05mm section difference, furthermore, mounting disc with larger axle diameter or load should have larger section difference to provide sufficient lock rigidity.

Table 11 Bolt number and bolt dimension

O. D. of outer ring, D (mm)	Bolt number	Bolt specification
100 below	8 (Included) more	M3~M5
100~200	12 (Included) more	M4~M8
200~500	16 (Included) more	M5~M12
500 above	24 (Included) more	M6 above

Table 12 Torque value of bolt

Bolt specification	Torque value (N-m)	Bolt specification	Torque value (N-m)
M3	2	M10	70
M4	4	M12	120
M5	9	M16	200
M6	14	M20	390
M8	30	M22	530

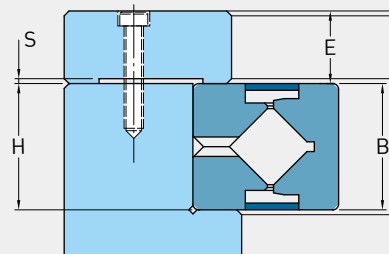

Installation steps

1. Inspect the parts before installing: Clean bearing bracket, main axle or other parts to remove dirt or grease.
2. Place the bearing into the bearing bracket and main axle: To match the design clearance, keep the bearing horizontal and insert the bearing into the bearing bracket or axle. If it is hard to install, use a rubber hammer to slightly hit evenly around the peripheral of the bearing in axial direction. So that the bearing can be inserted into the bearing bracket or axle easily. Pay close attention to the hitting force as the bearing could be damaged if the force is too large. Afterwards, the matching status of

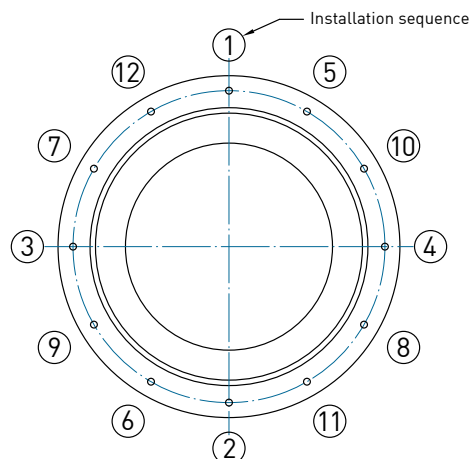

bearing and datum alignment can be examined by checking if there is noise detected due to misalignment. For an interference fit, use heating or cooling to expand or shrink the parts for ease of installation. Be sure the bearing temperature does not exceed 80°C . If the split inner or outer ring is acentric, please loosen the bolts slightly and rotate the monolithic ring to adjust the concentricity of split ring, so that the bearing can be fit in the bracket.

3. Install the mounting disc: Place the mounting disc onto the bearing and align the screw holes. Screw all the bolts in the holes first and follow the order as shown in above diagram when tightening bolts in diagonally opposite sequence. Do not tighten bolts at once.

Other Information

Lubrication

1. There is #2 Lithium/Calcium soap grease lubricant in all Crossed Roller Bearings. Delivered bearings can be used immediately as directed. If there is insufficient lubrication, the frictional resistance will increase and the service life will be reduced. The lubricant should be supplemented for the open bearing periodically, approximately every 1 ~ 6 months. The lubricating frequency depends on the application condition. The lubricant should be distributed evenly inside the bearing.
2. Avoid cross-mixing lubricants.
3. If the bearing is used in high vibration, clean room, vacuum, high or low temperature applications, a specific lubricant should be used, please contact HIWIN.

Allowable RPM

The allowable DN value of the Crossed Roller Bearing is 60000 mm•rpm. If the CRBB 05013 WW C8 P5 bearing is used, it has a roller PCD of 65 mm. So, the allowable rpm is about $60000/65 = 923$ rpm.

Cautions

1. The normal operating temperature of the bearing is 10 ~ 80 °C . If it is over this temperature range, please contact HIWIN.
2. If a foreign substance enters inside the bearing structure, the rotation route of the roller may be damaged, or the bearing may fail.
3. If a foreign substance enters inside the bearing structure, please clean it then refill the lubricant.
4. Please do not remove or apply force to the bolt and nut of the split bearing.

Product Specification

- Split outer ring type (CRBA), the bore diameter is 20 ~ 400 mm, sealed and open type.

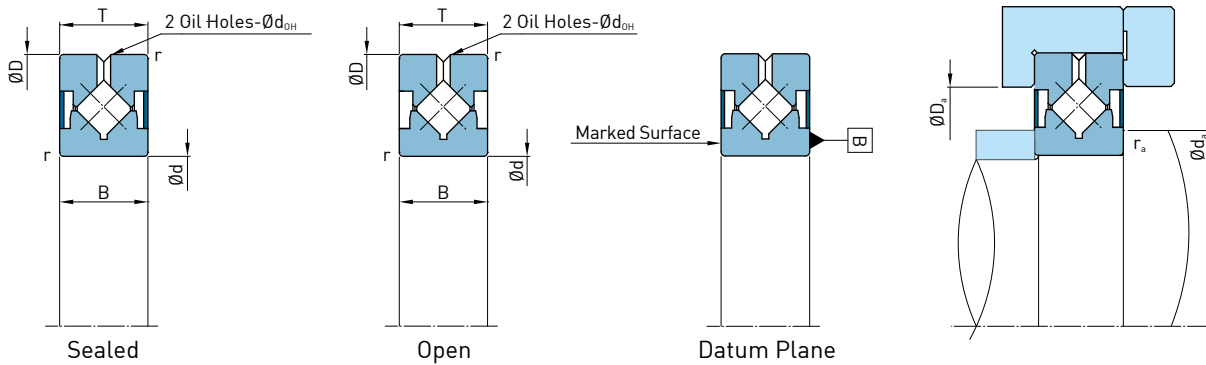

Dimensions (mm)			Bearing No.	Oil holes, d _{OH} (mm)	Basic load Ratings (kN)		Mounting dimensions (mm)		
Inner diameter (d)	Outer diameter (D)	Width (B, T)			Dynamic load, C	Static load, C ₀	d _a	D _a	r _a (max)
20	36	8	CRBA 02008	1.5	4.1	4	22.9	30.8	0.6
25	41	8	CRBA 02508	1.5	4.5	4.8	27.9	35.8	0.6
30	55	10	CRBA 03010	1.5	8.2	9.2	35	46.8	0.6
35	60	10	CRBA 03510	1.5	8.5	10	40	51.8	0.6
40	65	10	CRBA 04010	1.5	9.3	11.6	45	56.8	0.6
45	70	10	CRBA 04510	1.5	9.6	12.5	50	61.8	0.6
50	80	13	CRBA 05013	2	18.9	23.4	57.2	72	0.6
60	90	13	CRBA 06013	2	20.3	27	67	82	0.6
70	100	13	CRBA 07013	2	21.7	30.6	77	92	0.6
80	110	13	CRBA 08013	2	22.8	34.2	87	102	0.6
80	120	16	CRBA 08016	2.5	30.2	44.8	92	109	0.6
90	130	16	CRBA 09016	2.5	30.8	47.4	104	120	1
90	140	20	CRBA 09020	2.5	39.7	60.2	104	120	1
100	140	16	CRBA 10016	2.5	32.5	52.3	112	129	1
100	150	20	CRBA 10020	2.5	40.4	63.6	117	132	1
110	160	20	CRBA 11020	2.5	42.7	70.2	126	143	1
120	150	16	CRBA 12016	2.5	28.1	50.3	126	143	1
120	170	20	CRBA 12020	2.5	44.9	76.9	136	153	1.5
120	180	25	CRBA 12025	2.5	66.3	109	138	158	1.5
130	190	25	CRBA 13025	2.5	67.8	114.8	148	168	1.5
140	200	25	CRBA 14025	2.5	69.5	120.6	161	178	1.5
150	210	25	CRBA 15025	2.5	73.1	131.9	168	188	1.5
150	230	30	CRBA 15030	3	114.3	187.3	181	198	1.5
160	220	25	CRBA 16025	2.5	74.5	137.7	181	198	1.5
170	220	20	CRBA 17020	2.5	52.3	103.6	183	203	1.5
180	240	25	CRBA 18025	2.5	79.6	154.8	198	218	1.5
190	240	25	CRBA 19025	2.5	54.5	113.6	203	223	1
200	260	25	CRBA 20025	2.5	82.3	166.4	218	238	2
200	280	30	CRBA 20030	3	122.9	242	231	248	2
200	295	35	CRBA 20035	3	155.9	277.4	238	258	2
220	280	25	CRBA 22025	2.5	86.3	183.5	237	259	2
240	300	25	CRBA 24025	2.5	90.5	200.6	257	279	2
250	310	25	CRBA 25025	2.5	91.6	206.4	267	289	2
250	330	30	CRBA 25030	3	142	286.2	280	299	2
250	355	40	CRBA 25040	4	207	391.8	289	311	2
300	360	25	CRBA 30025	2.5	100.6	246.5	317	339	2.5
300	395	35	CRBA 30035	3	191.6	407.8	337	359	2.5
300	405	40	CRBA 30040	4	227	465.8	339	361	2.5
400	480	35	CRBA 40035	3	219.4	523.9	426	447	2.5

Notes: 1. The basic load ratings are based on ISO76 / ISO281.

2. For specific dimensional requirements, please contact HIWIN.

3. The inner ring datum plane B is for customer use, specification and product series number are marked on the surface.

Product Specification

- Split inner ring type (CRBB), the bore diameter is 30 ~ 400 mm, sealed and open type.

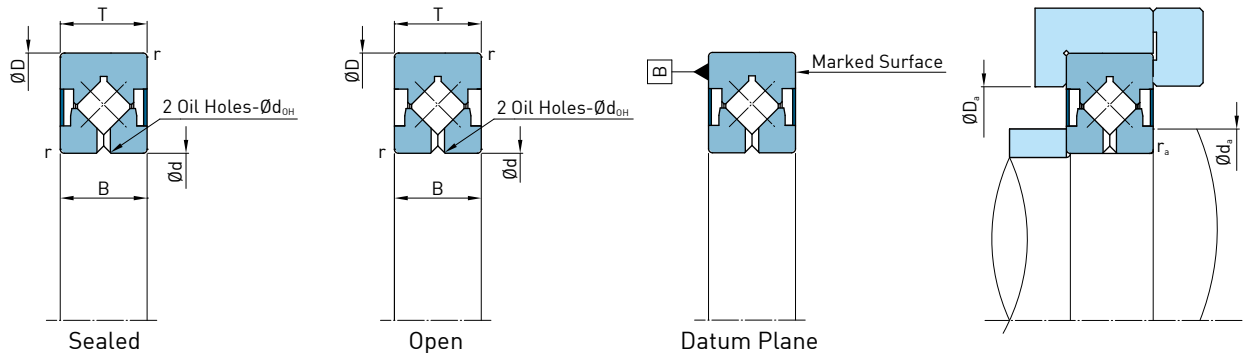

Dimensions (mm)			Bearing No.	Oil holes, d _{OH} (mm)	Basic load Ratings (kN)		Mounting dimensions (mm)		
Inner diameter (d)	Outer diameter (D)	Width (B, T)			Dynamic load, C	Static load, C ₀	d _a	D _a	r _a (max)
30	55	10	CRBB 03010	1.5	8.2	9.2	35	46.8	0.6
35	60	10	CRBB 03510	1.5	8.5	10	40	51.8	0.6
40	65	10	CRBB 04010	1.5	9.3	11.6	45	56.8	0.6
45	70	10	CRBB 04510	1.5	9.6	12.5	50	61.8	0.6
50	80	13	CRBB 05013	2	18.9	23.4	57.2	72	0.6
60	90	13	CRBB 06013	2	20.3	27	67	82	0.6
70	100	13	CRBB 07013	2	21.7	30.6	77	92	0.6
80	110	13	CRBB 08013	2	22.8	34.2	87	102	0.6
80	120	16	CRBB 08016	2.5	30.2	44.8	92	109	0.6
90	130	16	CRBB 09016	2.5	30.8	47.4	104	120	1
90	140	20	CRBB 09020	2.5	39.7	60.2	104	120	1
100	140	16	CRBB 10016	2.5	32.5	52.3	112	129	1
100	150	20	CRBB 10020	2.5	40.4	63.6	117	132	1
110	160	20	CRBB 11020	2.5	42.7	70.2	126	143	1
120	150	16	CRBB 12016	2.5	28.1	50.3	126	143	1
120	170	20	CRBB 12020	2.5	44.9	76.9	136	153	1.5
120	180	25	CRBB 12025	2.5	66.3	109	138	158	1.5
130	190	25	CRBB 13025	2.5	67.8	114.8	148	168	1.5
140	200	25	CRBB 14025	2.5	69.5	120.6	161	178	1.5
150	210	25	CRBB 15025	2.5	73.1	131.9	168	188	1.5
150	230	30	CRBB 15030	3	114.3	187.3	181	198	1.5
160	220	25	CRBB 16025	2.5	74.5	137.7	181	198	1.5
170	220	20	CRBB 17020	2.5	52.3	103.6	183	203	1.5
180	240	25	CRBB 18025	2.5	79.6	154.8	198	218	1.5
190	240	25	CRBB 19025	2.5	54.5	113.6	203	223	1
200	260	25	CRBB 20025	2.5	82.3	166.4	218	238	2
200	280	30	CRBB 20030	3	122.9	242	231	248	2
200	295	35	CRBB 20035	3	155.9	277.4	238	258	2
220	280	25	CRBB 22025	2.5	86.3	183.5	237	259	2
240	300	25	CRBB 24025	2.5	90.5	200.6	257	279	2
250	310	25	CRBB 25025	2.5	91.6	206.4	267	289	2
250	330	30	CRBB 25030	3	142	286.2	280	299	2
250	355	40	CRBB 25040	4	207	391.8	289	311	2
300	360	25	CRBB 30025	2.5	100.6	246.5	317	339	2.5
300	395	35	CRBB 30035	3	191.6	407.8	337	359	2.5
300	405	40	CRBB 30040	4	227	465.8	339	361	2.5
400	480	35	CRBB 40035	3	219.4	523.9	426	447	2.5

- Notes: 1. The basic load ratings are based on ISO76 / ISO281.
 2. For specific dimensional requirements, please contact HIWIN.
 3. The outer ring datum plane B is for customer use, specification and product series number are marked on the surface.

Product Specification

- High rigidity type (CRBC), the bore diameter is 20 ~ 400 mm, sealed and open type.

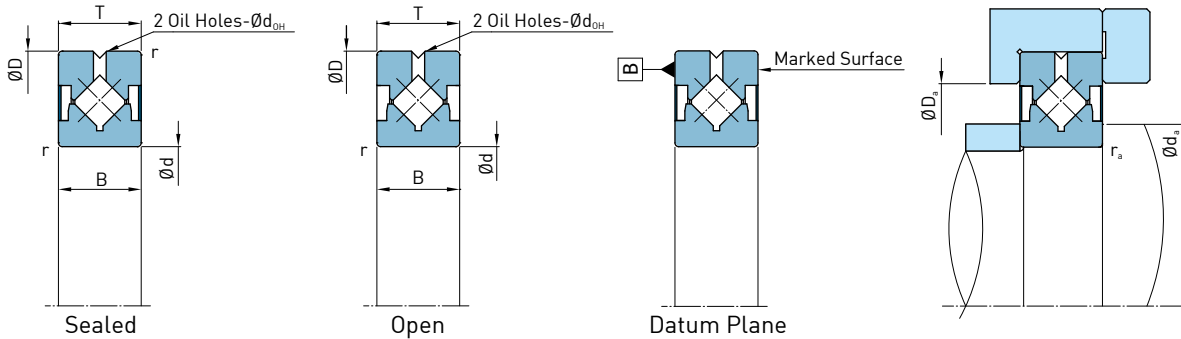

Dimensions (mm)			Bearing No.	Oil holes, d_{OH} (mm)	Basic load Ratings (kN)		Mounting dimensions (mm)		
Inner diameter (d)	Outer diameter (D)	Width (B, T)			Dynamic load, C	Static load, C_0	d_a	D_a	r_a (max)
20	36	8	CRBC 02008	1.5	4.1	4	22.9	30.8	0.6
25	41	8	CRBC 02508	1.5	4.5	4.8	27.9	35.8	0.6
30	55	10	CRBC 03010	1.5	8.2	9.2	35	46.8	0.6
35	60	10	CRBC 03510	1.5	8.5	10	40	51.8	0.6
40	65	10	CRBC 04010	1.5	9.3	11.6	45	56.8	0.6
45	70	10	CRBC 04510	1.5	9.6	12.5	50	61.8	0.6
50	80	13	CRBC 05013	2	18.9	23.4	57.2	72	0.6
60	90	13	CRBC 06013	2	20.3	27	67	82	0.6
70	100	13	CRBC 07013	2	21.7	30.6	77	92	0.6
80	110	13	CRBC 08013	2	22.8	34.2	87	102	0.6
80	120	16	CRBC 08016	2.5	30.2	44.8	92	109	0.6
90	130	16	CRBC 09016	2.5	30.8	47.4	104	120	1
90	140	20	CRBC 09020	2.5	39.7	60.2	104	120	1
100	140	16	CRBC 10016	2.5	32.5	52.3	112	129	1
100	150	20	CRBC 10020	2.5	40.4	63.6	117	132	1
110	160	20	CRBC 11020	2.5	42.7	70.2	126	143	1
120	150	16	CRBC 12016	2.5	28.1	50.3	126	143	1
120	170	20	CRBC 12020	2.5	44.9	76.9	136	153	1.5
120	180	25	CRBC 12025	2.5	66.3	109	138	158	1.5
130	190	25	CRBC 13025	2.5	67.8	114.8	148	168	1.5
140	200	25	CRBC 14025	2.5	69.5	120.6	161	178	1.5
150	210	25	CRBC 15025	2.5	73.1	131.9	168	188	1.5
160	220	25	CRBC 16025	2.5	74.5	137.7	181	198	1.5
170	220	20	CRBC 17020	2.5	52.3	103.6	183	203	1.5
180	240	25	CRBC 18025	2.5	79.6	154.8	198	218	1.5
190	240	25	CRBC 19025	2.5	54.5	113.6	203	223	1.5
200	260	25	CRBC 20025	2.5	82.3	166.4	218	238	2
400	480	35	CRBC 40035	3	219.4	523.9	426	447	2.5

- Notes: 1. The basic load ratings are based on ISO76 / ISO281.
 2. For specific dimensional requirements, please contact HIWIN.
 3. The outer ring datum plane B is for customer use, specification and product series number are marked on the surface.

Product Specification

- Split outer ring with mounting holes (CRBD), the bore diameter is 20 ~ 160 mm, sealed and open type.

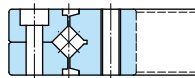
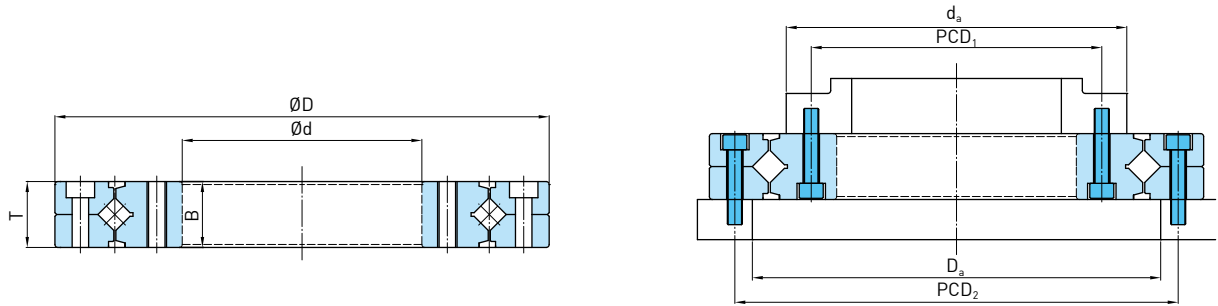

A type: Threaded holes on inner ring and counter-bored holes on outer ring.
CRBD 02012 A ~ CRBD 16035 A

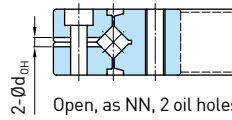

Open, as NN, 2 oil holes for lubrication.

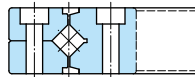

B type: Counter-bored holes on inner ring and outer ring, same direction.
CRBD 08022 B ~ CRBD 16035 B

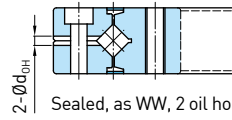

Sealed, as WW, 2 oil holes for lubrication.

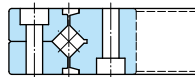

C type: Counter-bored holes on inner ring and outer ring, opposite direction
CRBD 08022 C ~ CRBD 16035 C

Dimensions (mm)					Bearing No.	Dimensions of mounting holes (mm)				Basic load Ratings (kN)		Mounting dimensions (mm)	
Inner dia. (d)	Outer dia. (D)	Width (B, T)	Chamfer (r _{min})	Oil holes (d _{oh})		Inner rings		Outer rings		Dynamic load, C	Static load, C ₀	d _a	D _a
						PCD ₁	Mounting holes	PCD ₂	Mounting holes				
20	70	12	0.6	3	CRBD 02012 A	28	6-M3 through	57	6-ø3.4 through ø6.5 counter bore depth 3.3	8.26	9.16	35	47
35	95	15	0.6	3	CRBD 03515 A	45	8-M4 through	83	8-ø4.5 through ø8 counter bore depth 4.4	18.9	23.4	57	73
55	120	15	0.6	3	CRBD 05515 A	65	8-M5 through	105	8-ø5.5 through ø9.5 counter bore depth 5.4	21.7	30.6	77	92
80	165	22	1	3	CRBD 08022 A	97	10-M5 through	148	10-ø5.5 through ø9.5 counter bore depth 5.4	40.4	63.6	117	132
					CRBD 08022 B								
					CRBD 08022 C								
90	210	25	1.5	3	CRBD 09025 A	112	12-M8 through	187	12-ø9 through ø14 counter bore depth 8.6	46	80.2	139	157
					CRBD 09025 B								
					CRBD 09025 C								
115	240	28	1.5	3	CRBD 11528 A	139	12-M8 through	217	12-ø9 through ø14 counter bore depth 8.6	73.1	131.9	168	188
					CRBD 11528 B								
					CRBD 11528 C								
160	295	35	2	6	CRBD 16035 A	184	12-M10 through	270	12-ø11 through ø17.5 counter bore depth 10.8	102	192.3	218	238
					CRBD 16035 B								
					CRBD 16035 C								

Notes: 1. The basic load ratings are based on ISO76 / ISO281.

2. For specific dimensional requirements, please contact HIWIN.

Product Specification

- High rigidity with mounting holes (CRBE), the bore diameter is 20 ~ 210 mm, sealed and open type.

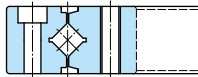
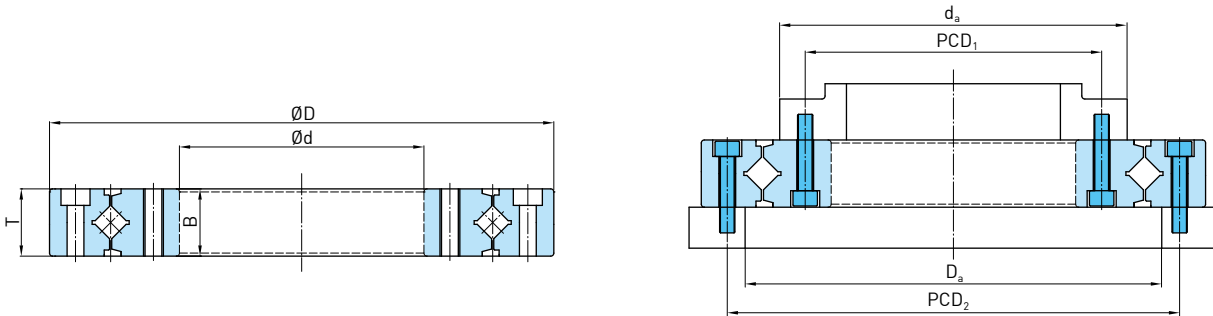

A type: Threaded holes on inner ring and counter-bored holes on outer ring.
CRBE 02012 A ~ CRBE 21040 A

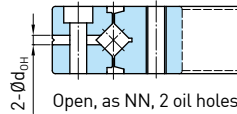

Open, as NN, 2 oil holes for lubrication.

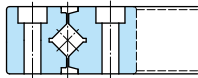

B type: Counter-bored holes on inner ring and outer ring, same direction.
CRBE 08022 B ~ CRBE 21040 B

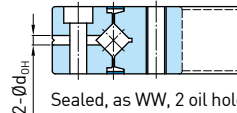

Sealed, as WW, 2 oil holes for lubrication.

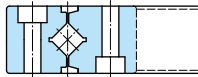

C type: Counter-bored holes on inner ring and outer ring, opposite direction.
CRBE 08022 C ~ CRBE 21040 C

Dimensions (mm)					Bearing No.	Dimensions of mounting holes (mm)				Basic load ratings (kN)		Mounting dimensions (mm)	
Inner dia. (d)	Outer dia. (D)	Width (B, T)	Chamfer (r _{min})	Oil holes (d _{OH})		Inner rings		Outer rings		Dynamic load, C	Static load, C ₀	d _a	D _a
						PCD ₁	Mounting holes	PCD ₂	Mounting holes				
20	70	12	0.6	3	CRBE 02012 A	28	6-M3 through	57	6-ø3.4 through ø6.5 counter bore depth 3.3	8.26	9.16	35	47
35	95	15	0.6	3	CRBE 03515 A	45	8-M4 through	83	8-ø4.5 through ø8 counter bore depth 4.4	18.9	23.4	57	73
55	120	15	0.6	3	CRBE 05515 A	65	8-M5 through	105	8-ø5.5 through ø9.5 counter bore depth 5.4	21.7	30.6	77	92
80	165	22	1	3	CRBE 08022 A	97	10-M5 through	148	10-ø5.5 through ø9.5 counter bore depth 5.4	40.4	63.6	117	132
					CRBE 08022 B								
					CRBE 08022 C								
90	210	25	1.5	3	CRBE 09025 A	112	12-M8 through	187	12-ø9 through ø14 counter bore depth 8.6	46	80.2	139	157
					CRBE 09025 B								
					CRBE 09025 C								
115	240	28	1.5	3	CRBE 11528 A	139	12-M8 through	217	12-ø9 through ø14 counter bore depth 8.6	73.1	131.9	168	188
					CRBE 11528 B								
					CRBE 11528 C								
160	295	35	2	6	CRBE 16035 A	184	12-M10 through	270	12-ø11 through ø17.5 counter bore depth 10.8	102	192.3	218	238
					CRBE 16035 B								
					CRBE 16035 C								
210	380	40	2.5	6	CRBE 21040 A	240	16-M12 through	350	16-ø14 through ø20 counter bore depth 13	142	286.2	277	299
					CRBE 21040 B								
					CRBE 21040 C								

Notes: 1. The basic load ratings are based on ISO76 / ISO281.
2. For specific dimensional requirements, please contact HIWIN.

Crossed Roller Bearings Technical Information

Publication Date : November 2012, first edition

Print Date : August 2014, 3rd edition

-
1. HIWIN is the registered trademark of HIWIN Technologies Corp.. For your protection; To avoid counterfeit products, be certain you are buying genuine HIWIN products before purchase.
 2. Actual products may be different from the specifications and photos in this catalog. The differences in appearances or specifications may be caused by, among other things, product improvements.
 3. HIWIN will not sell or export those techniques and products restricted under the "Foreign Trade Act" and relevant regulations. Any export of restricted products should be approved by competent authorities in accordance with relevant laws, and shall not be used to manufacture or develop nuclear, biochemical, missile and other military weapons.
 4. HIWIN website for patented product directory: http://www.hiwin.tw/Products/Products_patents.aspx

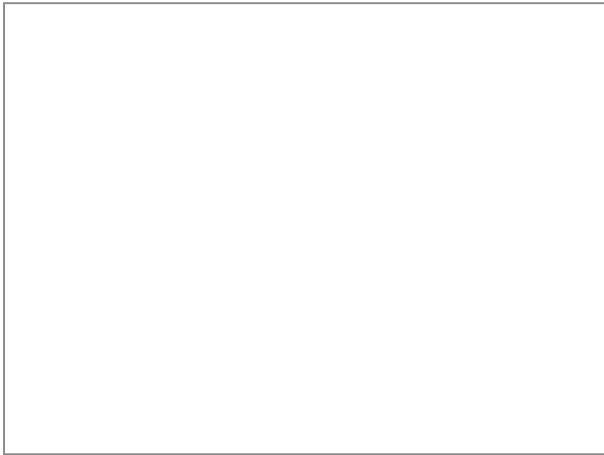

HIWIN TECHNOLOGIES CORP.

No. 7, Jingke Road,
Taichung Precision Machinery Park,
Taichung 40852, Taiwan
Tel: +886-4-23594510
Fax: +886-4-23594420
www.hiwin.tw
business@hiwin.tw

Subsidiaries & R&D Centers

HIWIN GmbH

OFFENBURG, GERMANY
www.hiwin.de
www.hiwin.eu
info@hiwin.de

HIWIN JAPAN

KOBE · TOKYO · NAGOYA · NAGANO ·
TOHOKU · HOKURIKU · HIROSHIMA ·
KUMAMOTO · FUKUOKA, JAPAN
www.hiwin.co.jp
info@hiwin.co.jp

HIWIN USA

CHICAGO · SILICON VALLEY, U.S.A.
www.hiwin.com
info@hiwin.com

HIWIN Srl

BRUGHERIO, ITALY
www.hiwin.it
info@hiwin.it

HIWIN Schweiz GmbH

JONA, SWITZERLAND
www.hiwin.ch
info@hiwin.ch

HIWIN FRANCE

ECHAUFFOUR, FRANCE
www.hiwin.fr
info@hiwin.fr

HIWIN s.r.o.

BRNO, CZECH REPUBLIC
www.hiwin.cz
info@hiwin.cz

HIWIN SINGAPORE

SINGAPORE
www.hiwin.sg
info@hiwin.sg

HIWIN KOREA

SUWON, KOREA
www.hiwin.kr
info@hiwin.kr

HIWIN CHINA

SUZHOU, CHINA
www.hiwin.cn
info@hiwin.cn

Mega-Fabs Motion System, Ltd.

HAIFA, ISRAEL
www.mega-fabs.com
info@mega-fabs.com